



FUTURE RECYCLING ROOM & A FIXING PACKAGE FOR EXISTING ONES

TONI GRÖNMARK MIRA HÖLTTÄ EMMI KAINULAINEN

HOW CAN WE
HELP & ENCOURAGE
PEOPLE TO RECYCLE
MORE & BETTER ?

WE STARTED OUR
PROJECT BY INTERVIEWING PEOPLE

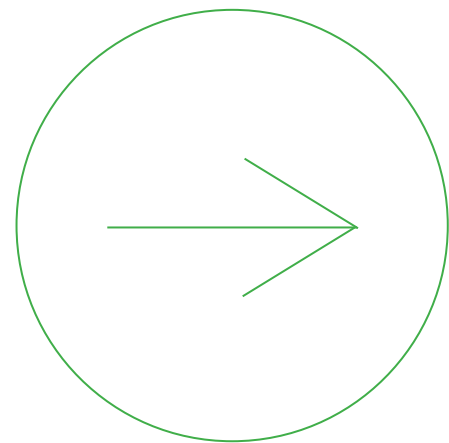

WE GOT OVER 100 ANSWERS

THE RESULTS OF INTERVIEWS

AGE RANGE 19 - 68 YEARS

84% OF RESPONDENTS WERE FEMALE

16% OF RESPONDENTS WERE MEN

SHORTCOMINGS WHICH WE FOUND

PEOPLE WANTED MORE

INTRESTED
ABOUT RECYCLING

96%

INTRESTED
ABOUT TRADE SHELF

30%

INFORMATION

27%

LIGHT

24%

COLORS

12%

HYGIENE

5%

BASED ON THE INTERVIEW RESULTS WE
WANTED TO TO PICK UP FEW ELEMENTS
FOR THE PERFECT RECYCLING ROOM

OUR THOUGHTS & IDEAS FOR THE PERFECT RECYCLING ROOM

HYGIENE

No touching

The opportunity to wash your hands

Clean place - you don't have to see the garbagebins



BRIGHT

You can see clearly

A place with good lighting - more daylight



TECHNOLOGY & SAFETY

Doesn't need to use the key
--> doors will open when you
go close

Have the option to lock the
doors



KNOWLEDGE

Knowledge where
to put all the stuff

A new perspective
for signboards



WE ENDED UP MAKING TWO DIFFERENT CONCEPTS

— **ONE:** a fixing package for the existing sheds

The fixing package will include the elements that are missing in the existing sheds, such as lighting and hygienia

— **TWO:** the whole new shed model with a smart recycling wall

CONCEPT ONE a fixing package for the existing sheds

— a roof panel lighting that brings smooth led light all around the room as there would be daylight 24/7

— a hygienic module which contains hand disinfecting towels, trash bin and a scent machine that will automatically freshen the room

— better information which includes clear symbols and pictures what goes where

— bright colors that make remembering easier (f.e. children and the elderly)

CONCEPT TWO a whole new shed model

technology the doors will open automatically when you go close

a hygienic module which contains hand disinfecting towels, trash bin and a scent machine that will automatically freshen the room

better information which includes clear symbols and pictures what goes where

bright colors that make remembering easier (f.e. children and the elderly)

CONCEPT TWO FUTURE RECYCLING ROOM

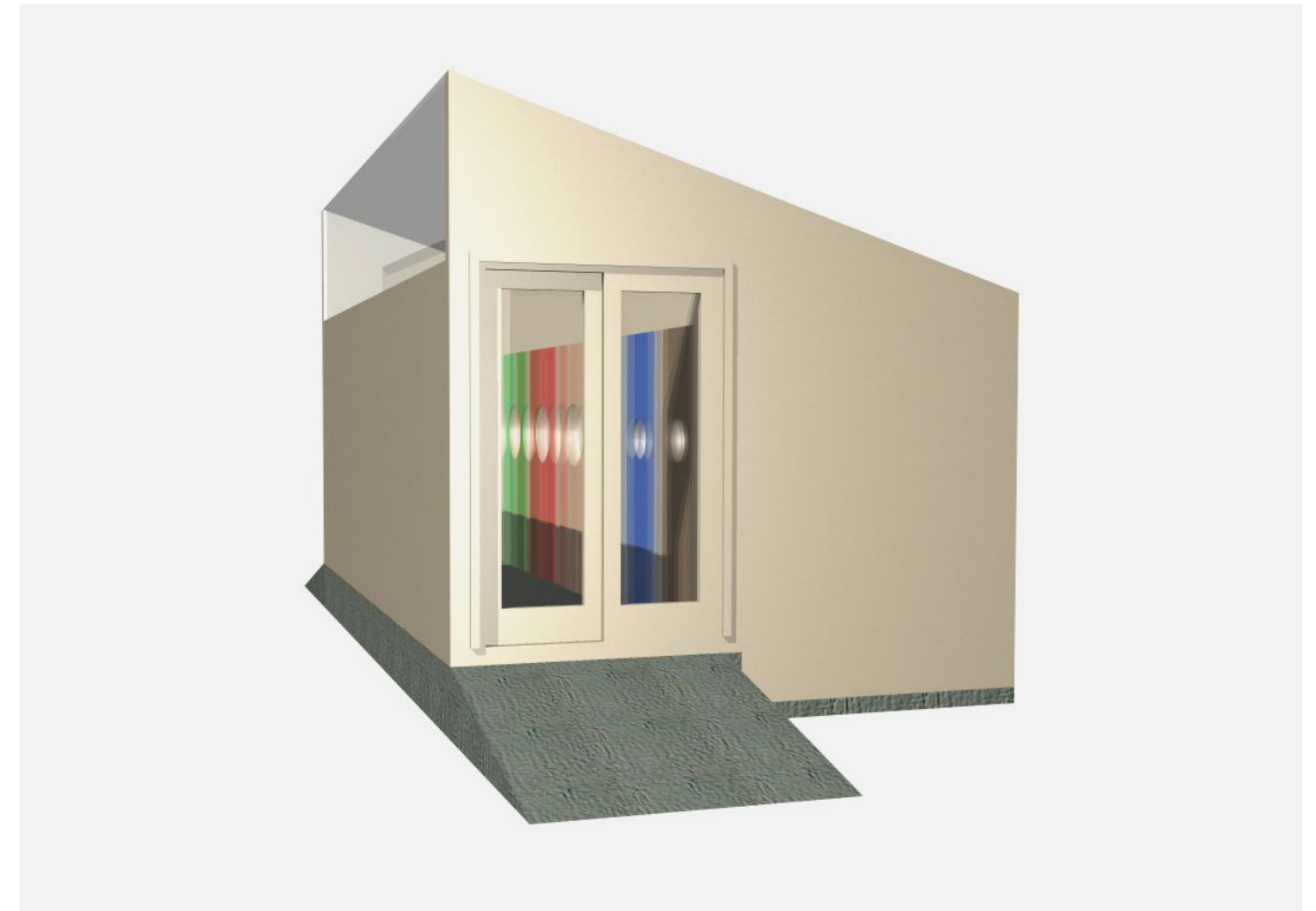
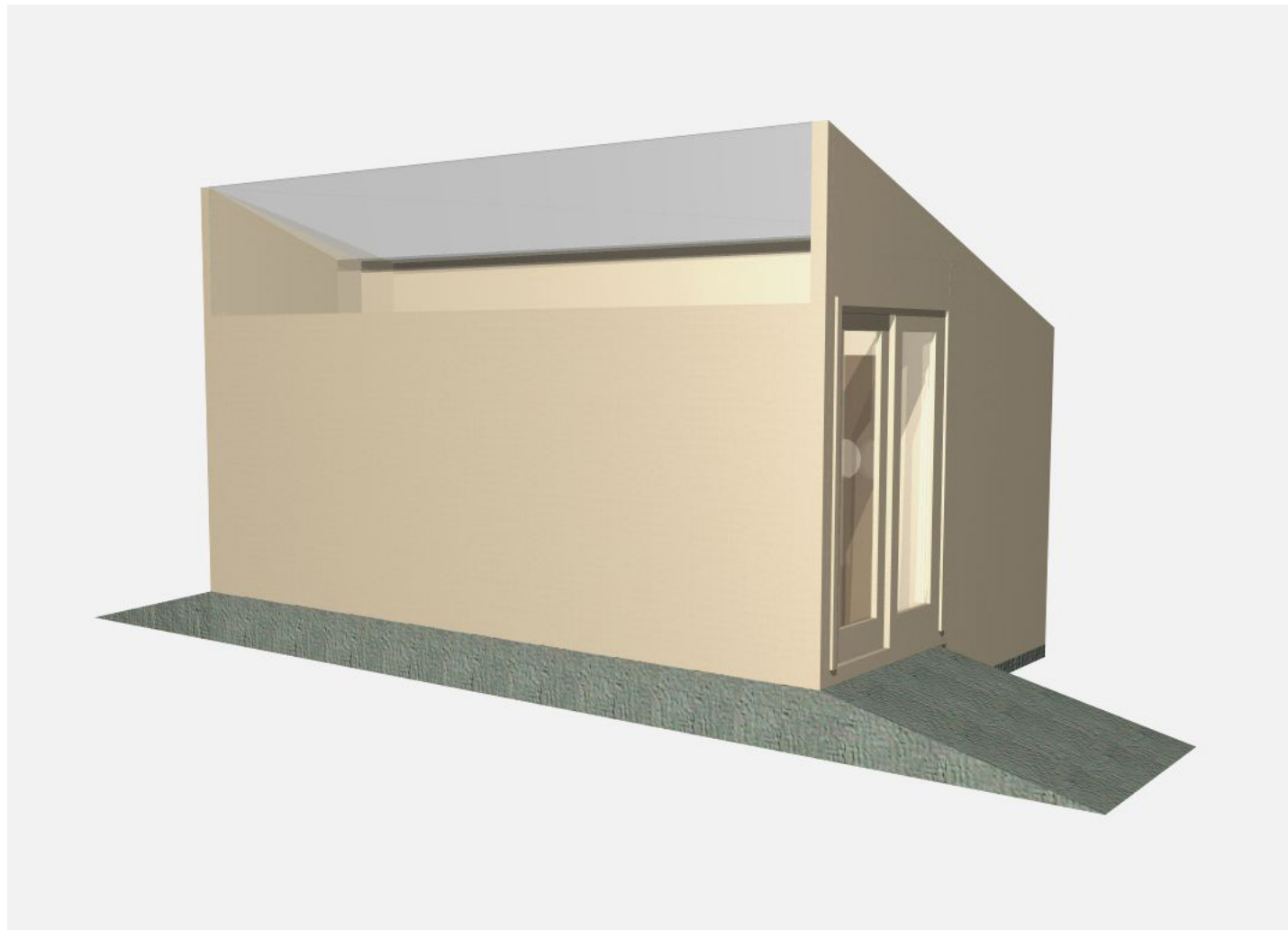





THOUGHTS
ABOUT
DIMENSIONING
AND
FLOOR PLANS

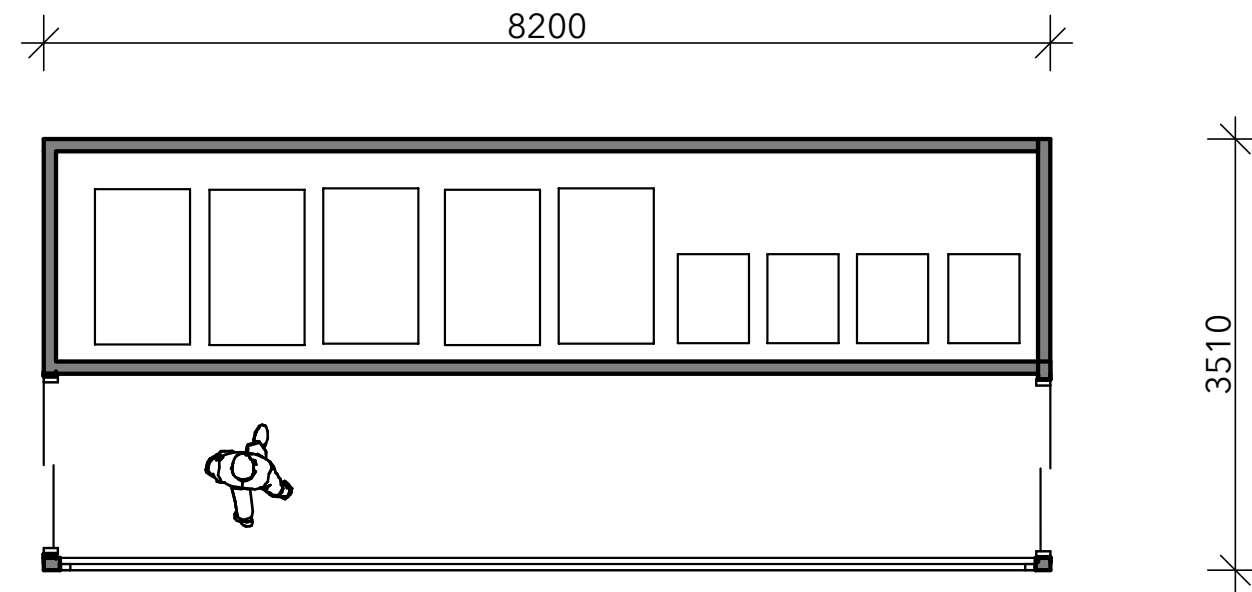
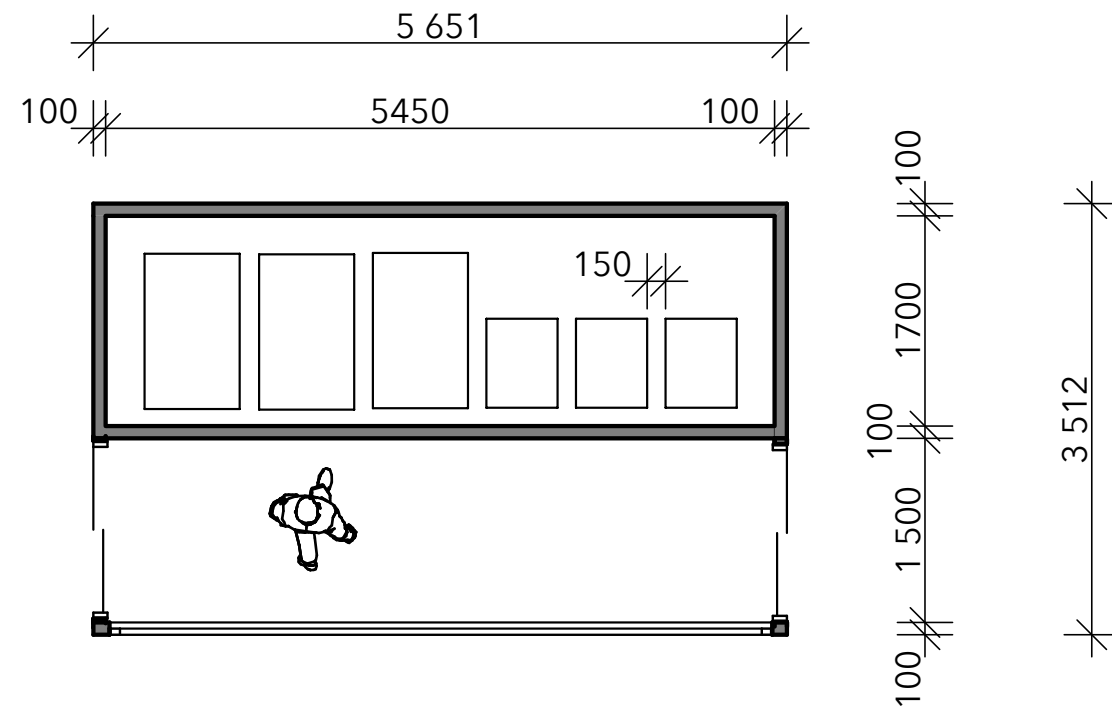

ESIMERKKI
SJOITTELUSTA

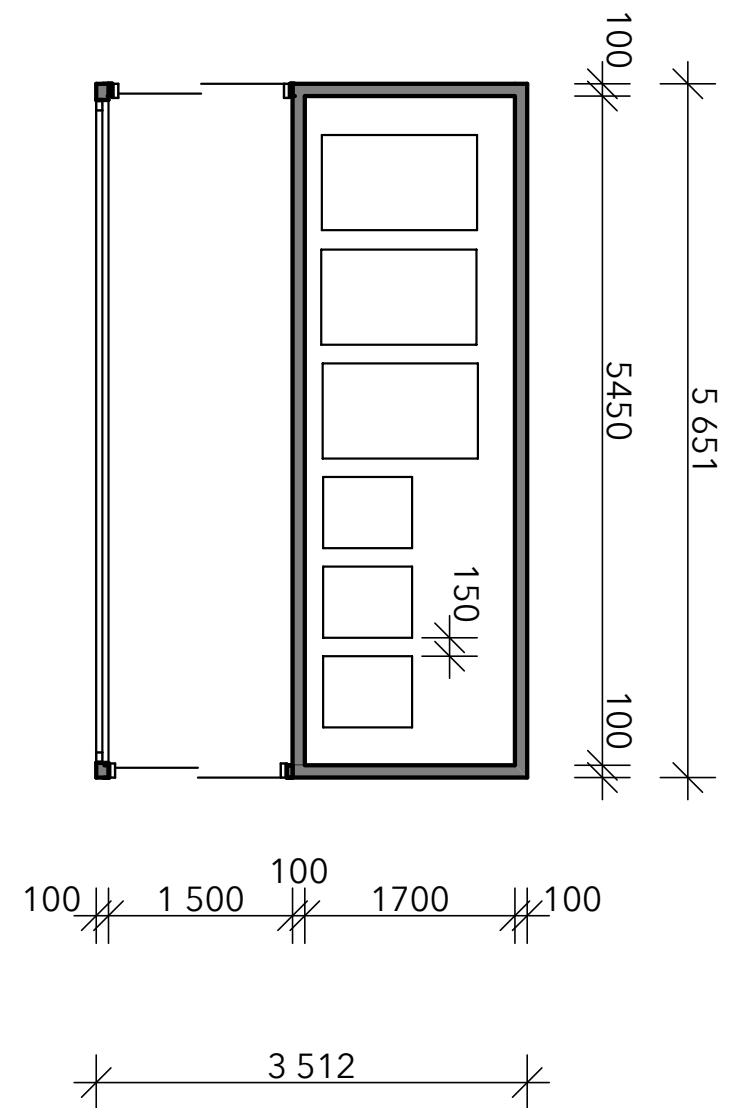
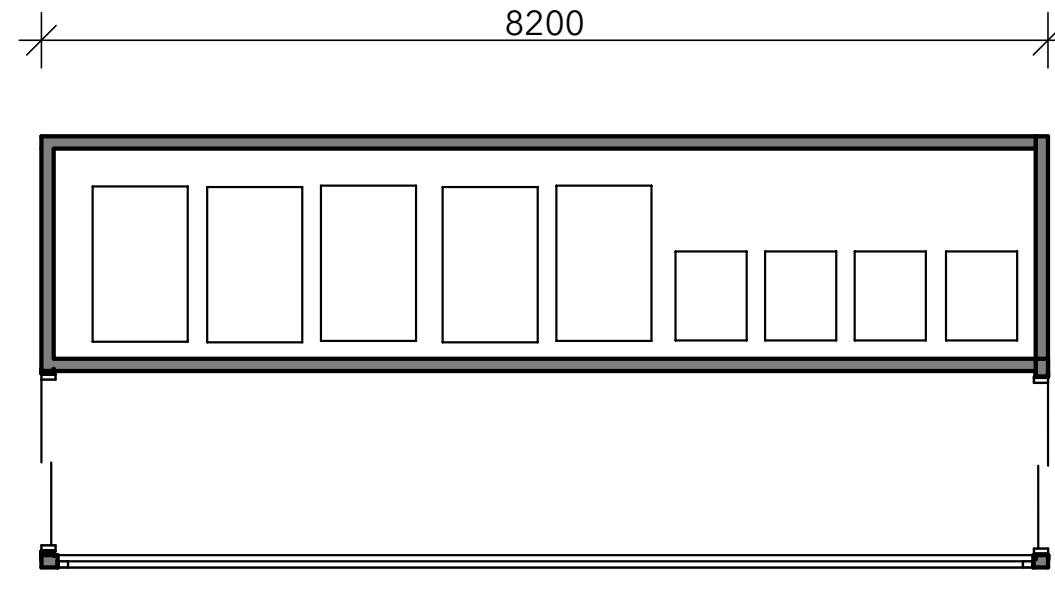

L&T SIDE

TIP-UP DOOR

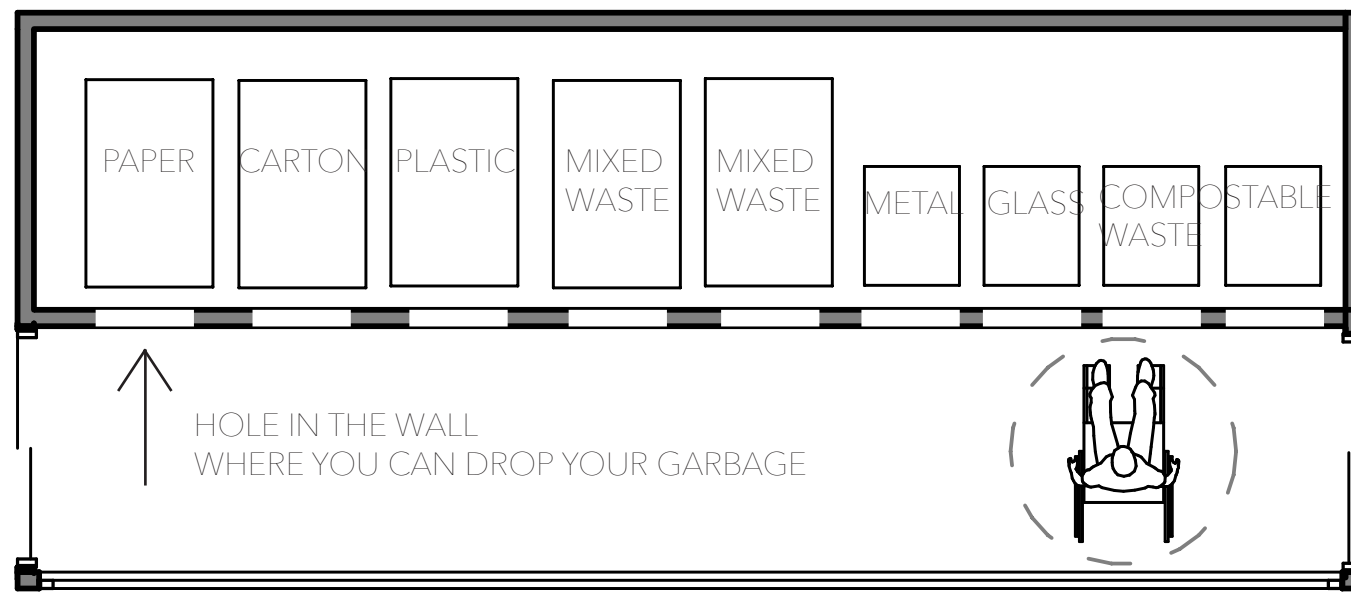

ENOUGH SPACE FOR WHEELCHAIRS

GLASS DOOR

GLASS WALL

CUSTOMERS SIDE

L&T SIDE

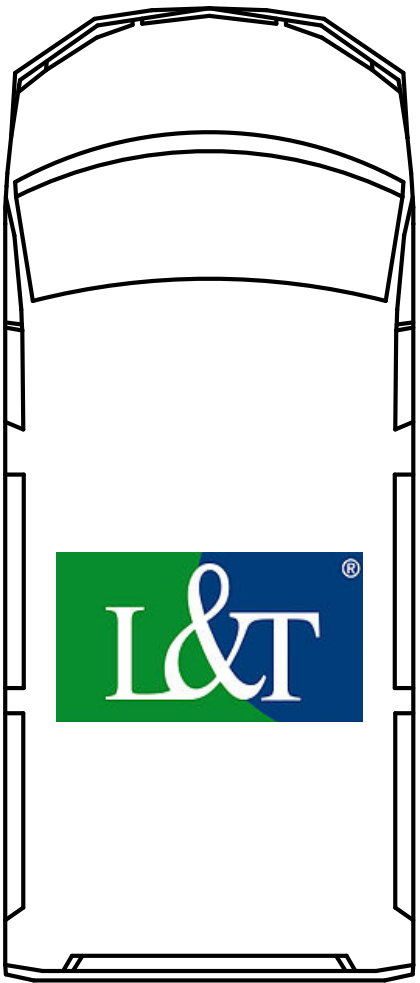

↓ TIP-UP DOOR
OPEN

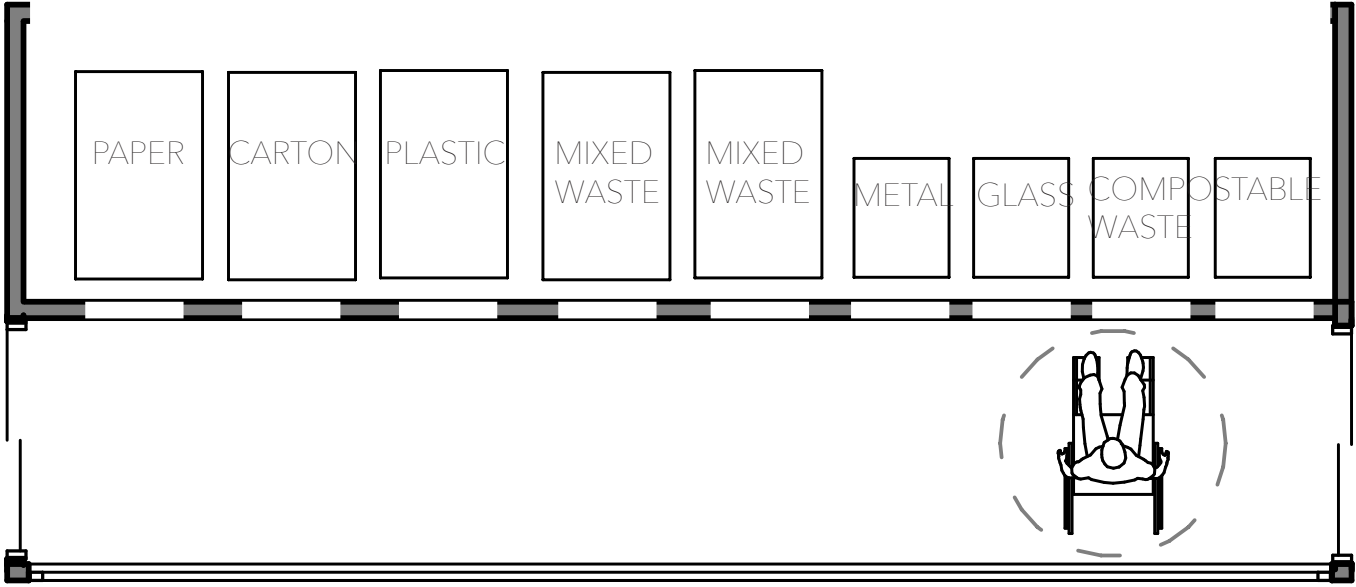

CUSTOMERS SIDE

SIDE PROJECTIONS WITH AN INNOVATIVE TUBE SYSTEM

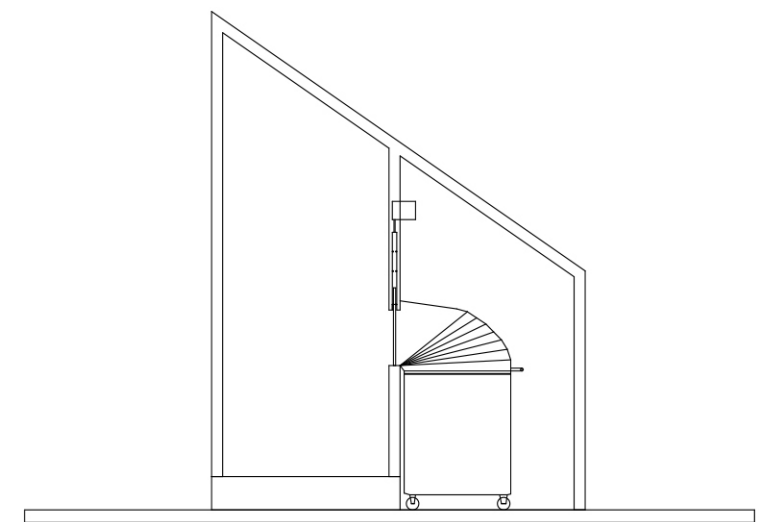
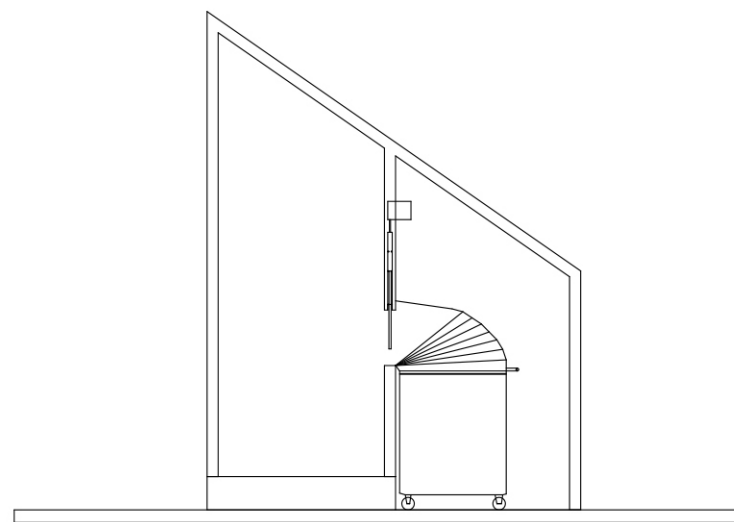
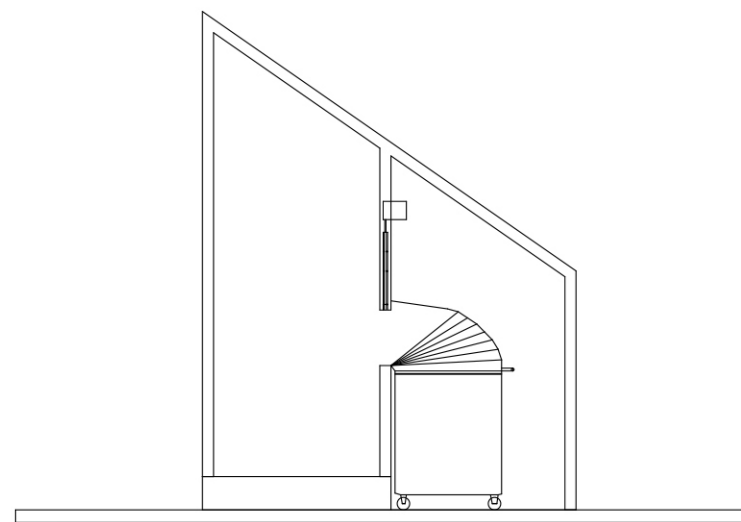

THE TUBE SYSTEM IS EASY FOR THE L&T EMPLOYEE

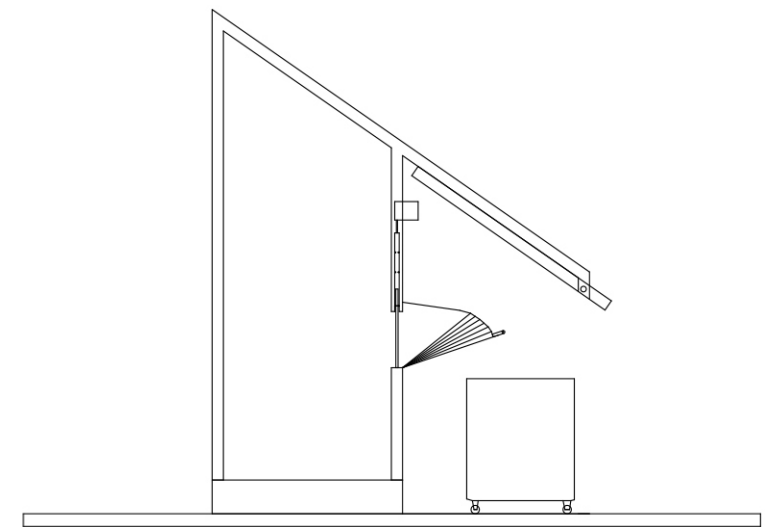
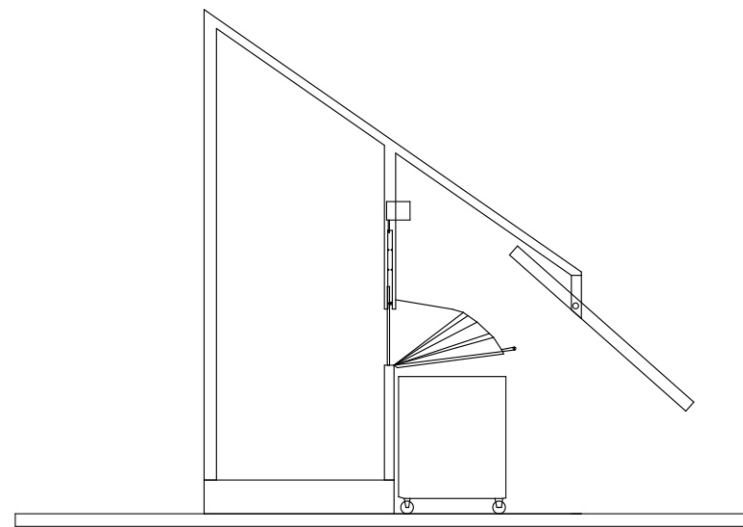
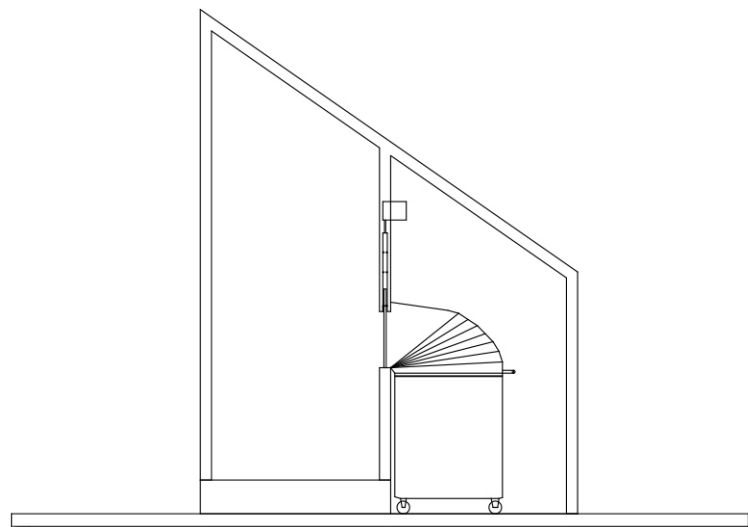

THE TUBE SYSTEM WITH MEASUREMENTS

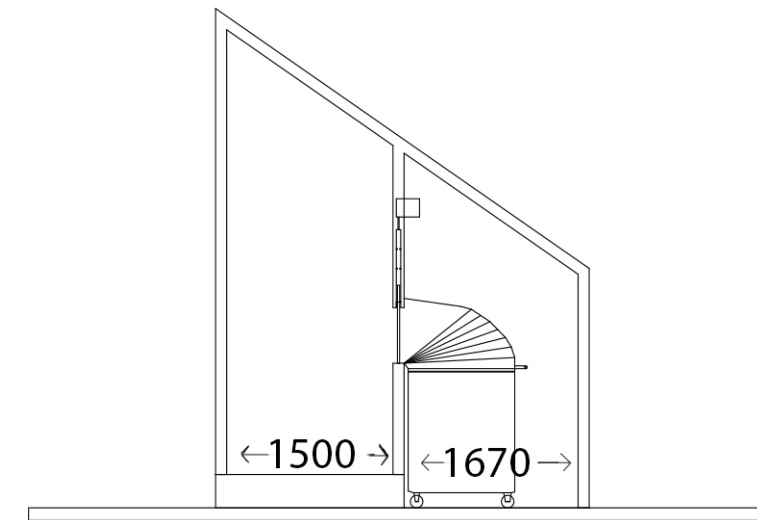
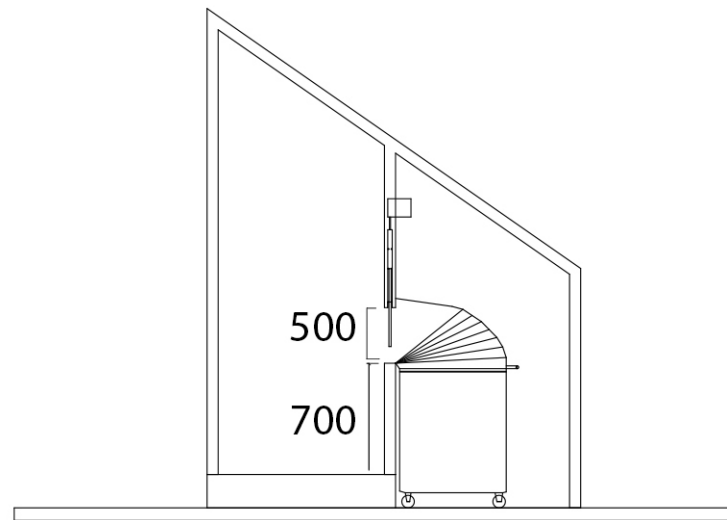
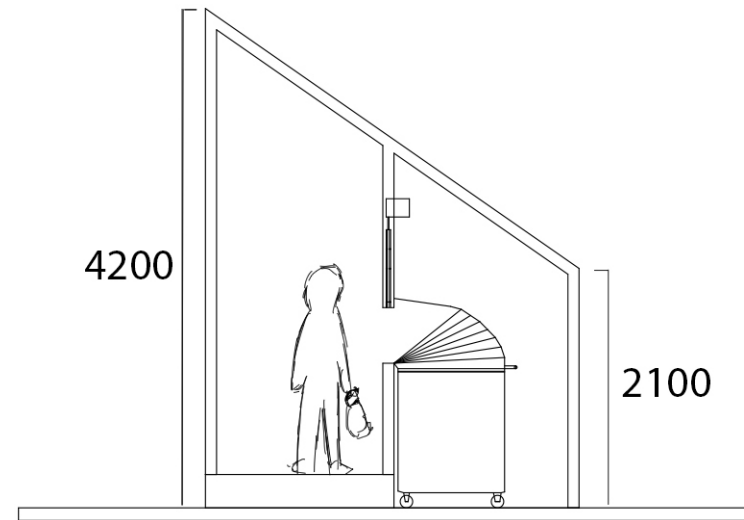

FIRST SKETCHES

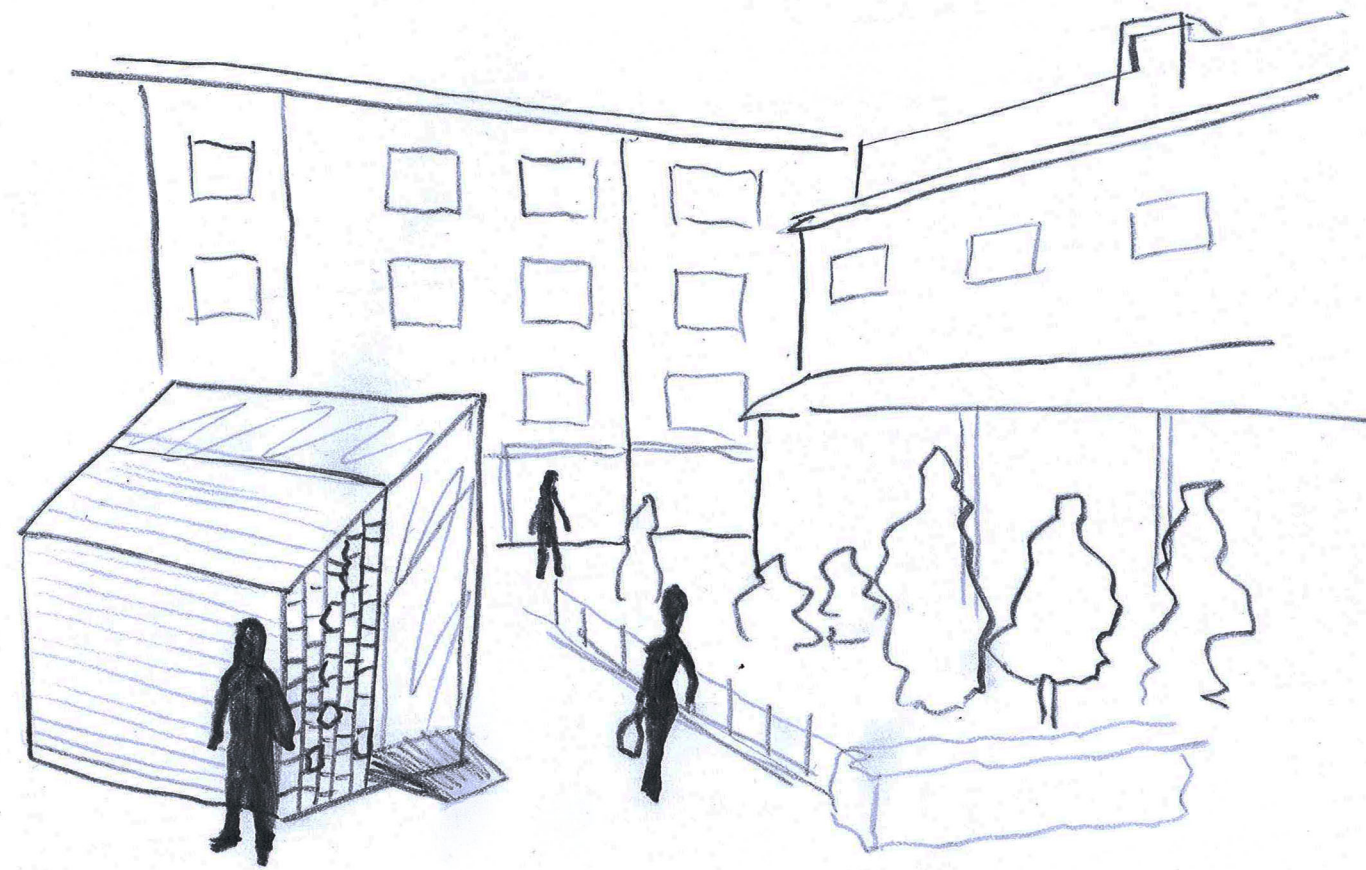

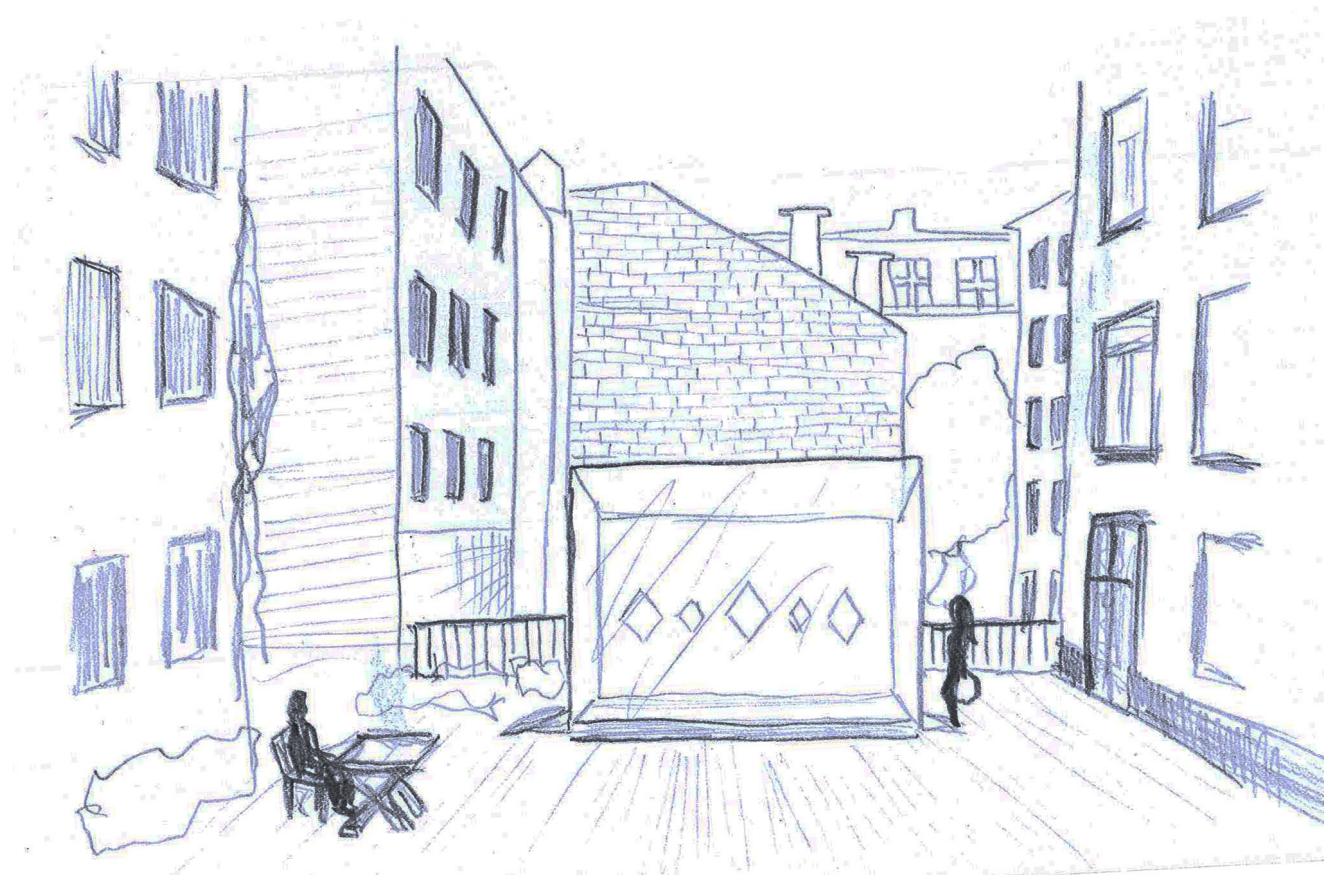

AUTOMATIC



OPENING SYSTEMS FOR THE LIDS

HYGIENIC



HAND DESINFECTING TOWELS
NO TOUCHING

INFORMATIC



DIGITAL INFORMATION SCREEN / BOARD

LIGHTING



LED- LIGHTING, MORE LIGHTING SOURCES