

# Route of Experience, tourist routes

---

Bicycle routes and lanes

Karppanen

Keinänen

Vuokila

# Guided routes for tourists in helsinki

---

Different type of routes to different type of tourists, for example:

## Diverse Helsinki

Route gives cross-section of different sides of Helsinki: Urban city-view and nice landscapes at the seashore. Old town gives historical point of view to the route.

## Marine Helsinki

Marine Helsinki route goes along seashore and archipelago. Landscape route views some of the beautiful nature of Helsinki.

## Helsinki in January

Helsinki in January offers extreme experiences, such as cycling on ice and snow.

# Guideposts and self-service stations

---

Guideposts able tourists to stay in the chosen route and gives information about inspiring and sensual places. The information is integrated to the guideposts.

We choose different materials to represent different routes.

The guidepost places are related to culture, nature, history and beautiful landscapes.

Self-service stations are located in bicycle center, places where the routes combines and in routes zeniths.

Self-service stations are sheltered. Stations include bikeparking and benches.



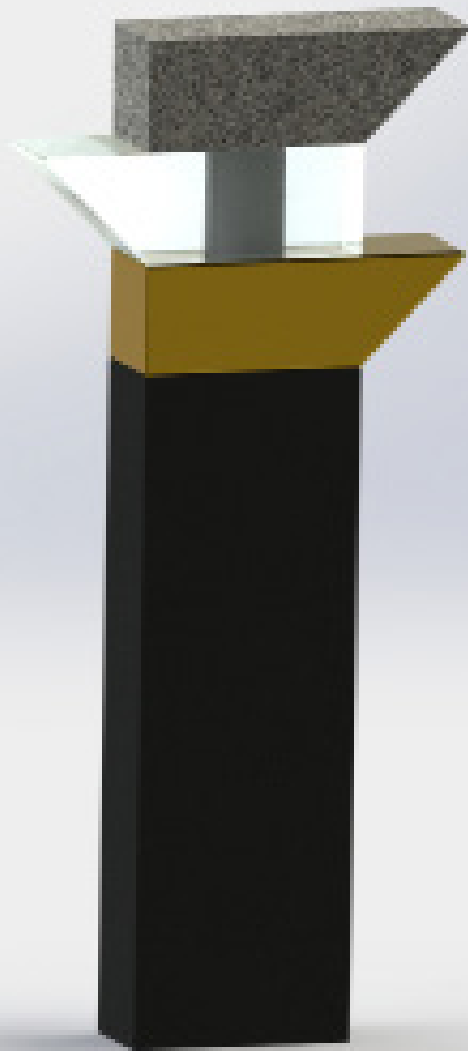

# Guidepost

---

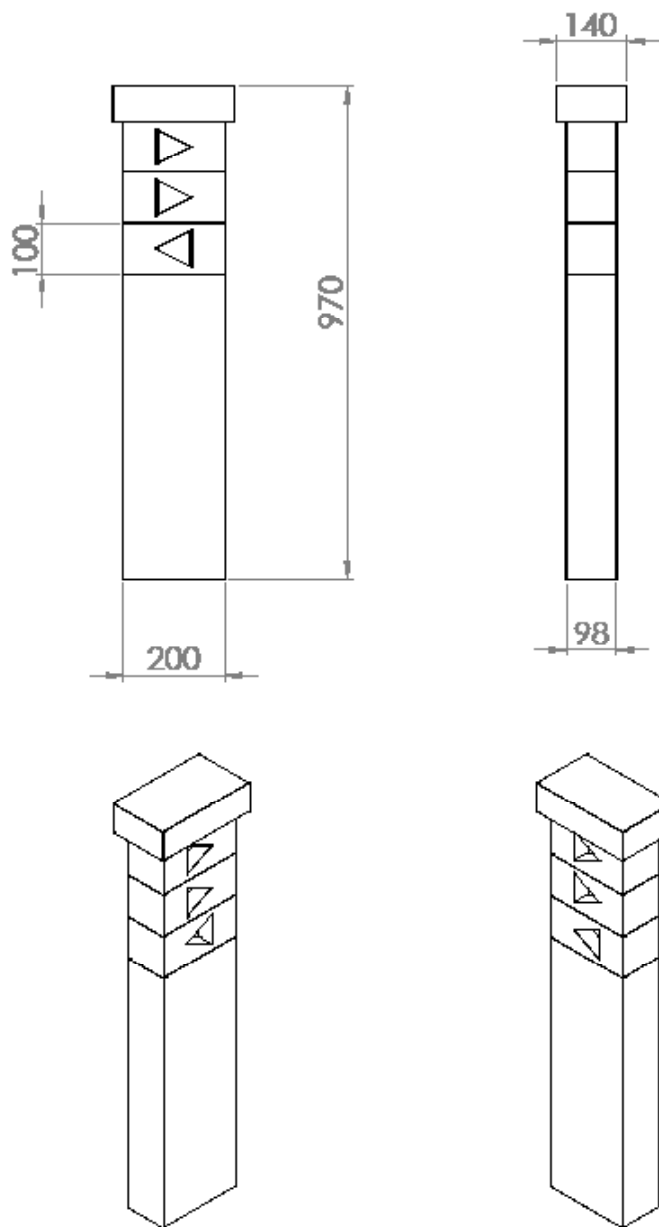

All guideposts have the same concrete base and they are designed to be modified with different materials.

Each route is marked with a different material

The blocks works also as lampposts



Blocks can be removed

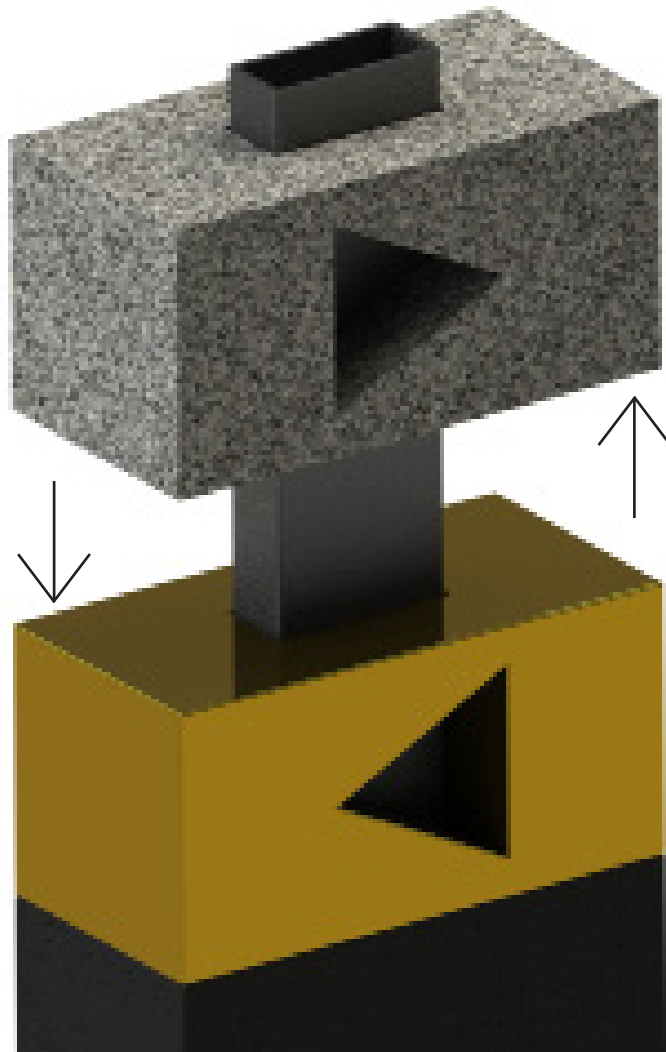

# Self Service Station

There will be 5 self-service stations along the routes.

Self-service stations includes basic tools for bicycle fixing and maintenance

There are benches in the backside of the station.

Stations can be used by tourists using the route, or local people living in the area.

Process:

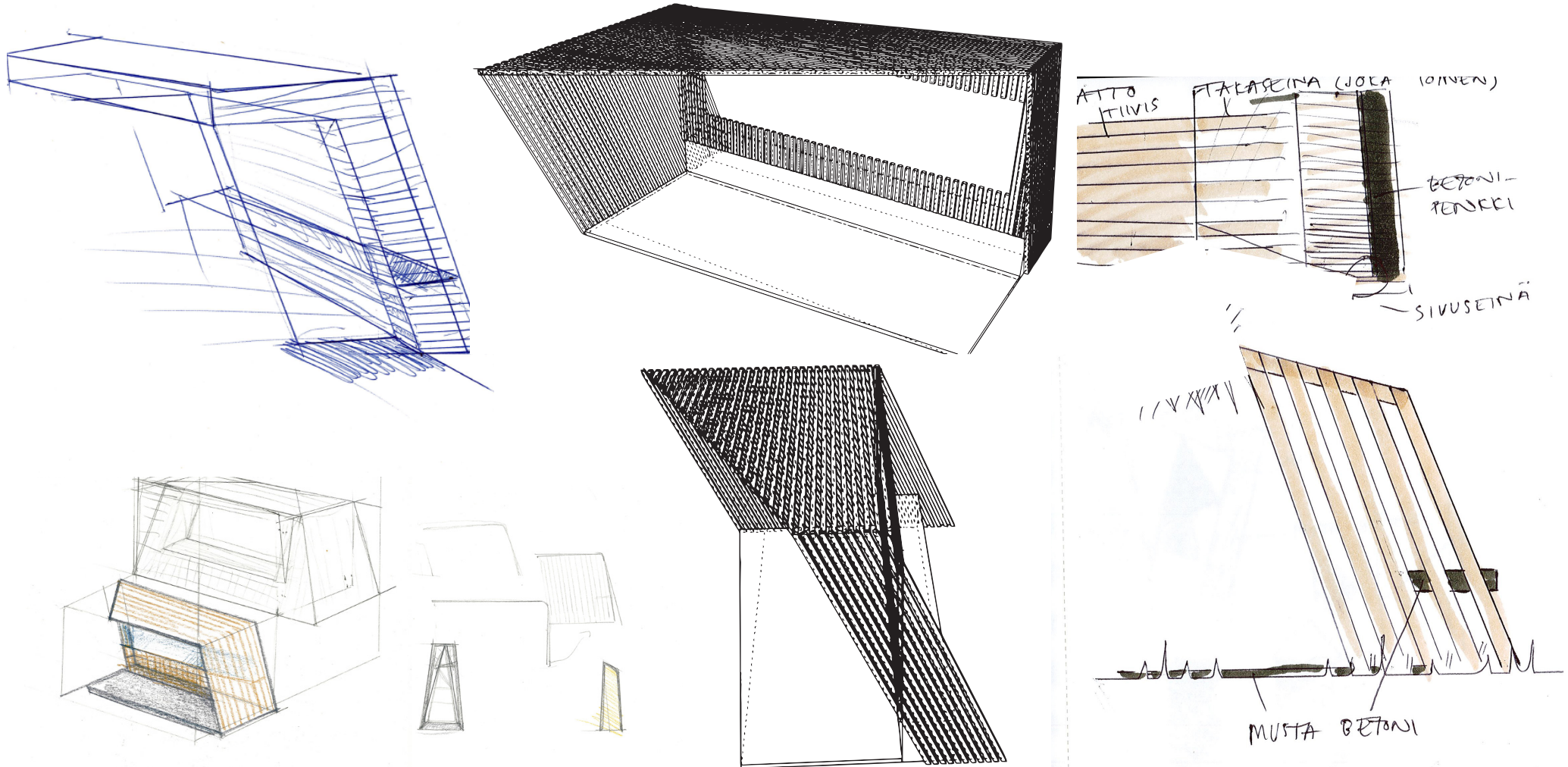



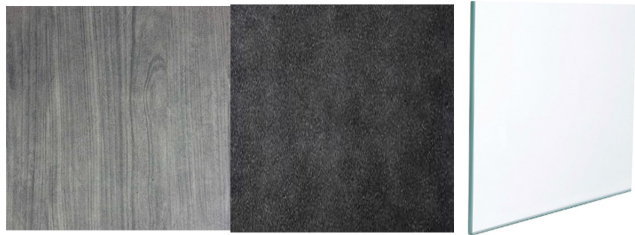
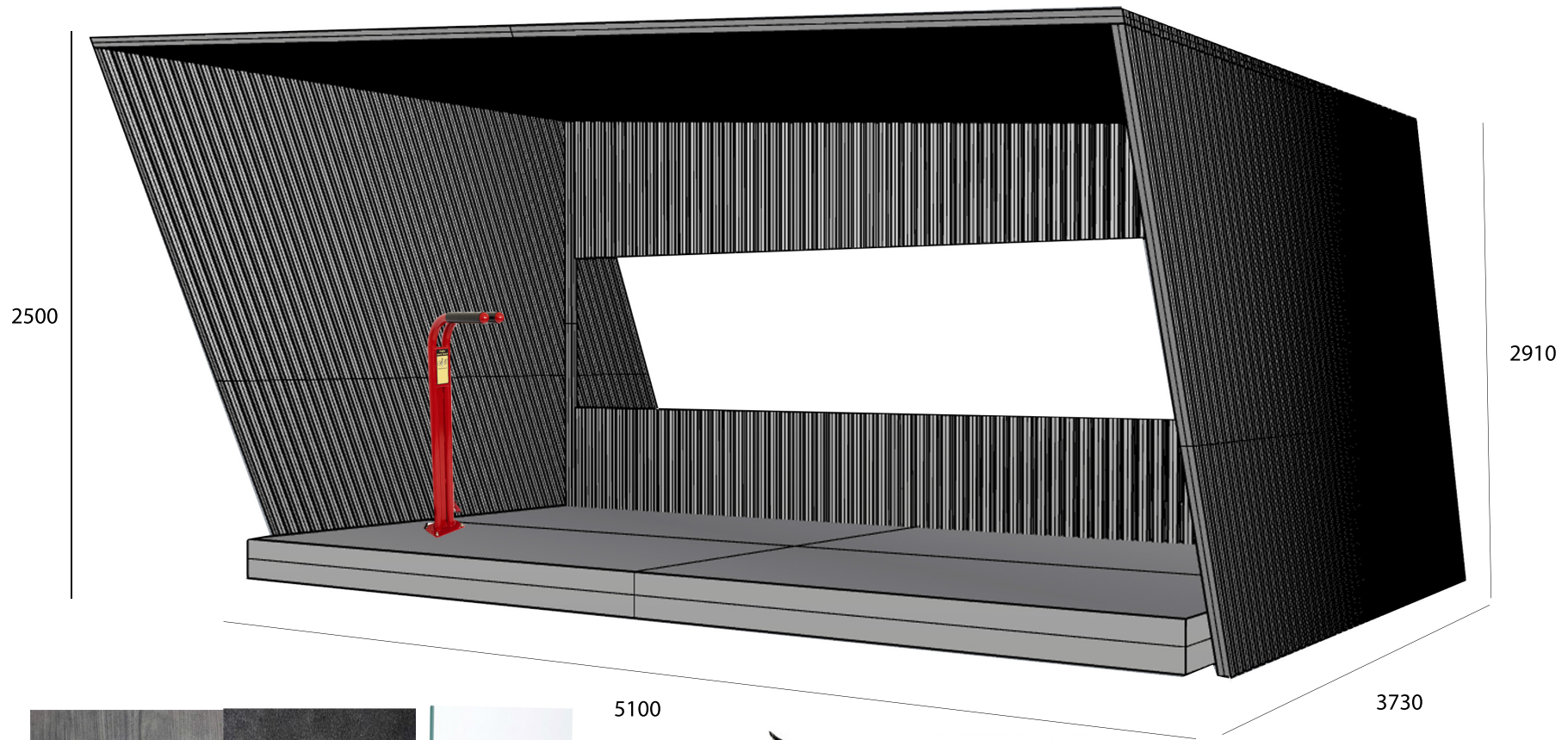

5100



x2









← to the roof

Materials: Wood, black concrete, glass.

# Map

---

-  Bicycle Center
-  Service Station
-  Route Diverse
-  Route Marine
-  Route January
-  Short cuts

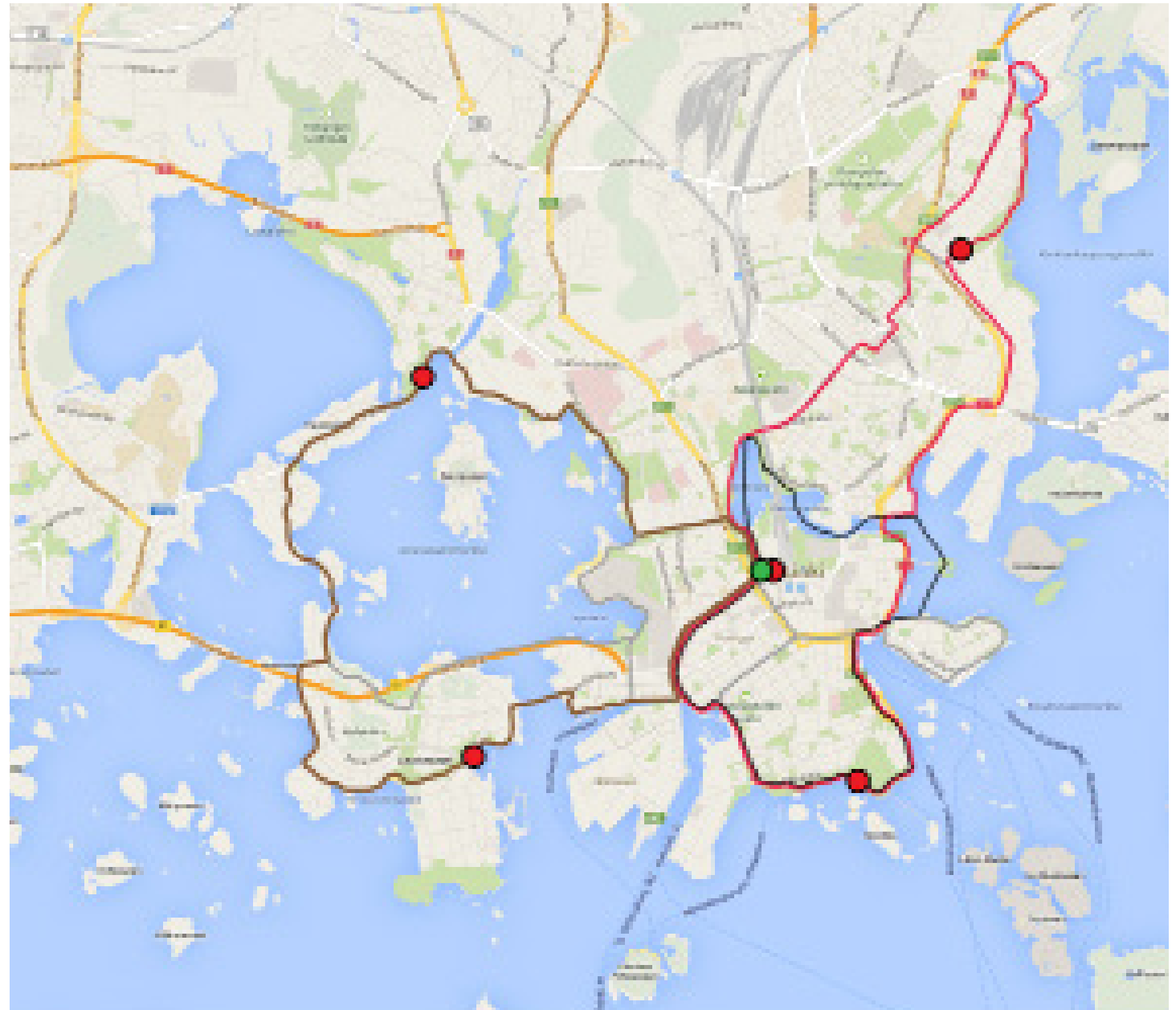

# Next Step

---

- Finishing the design of quidepost, map, and self-service station.

  - Details

  - 3D-modelling

  - Mock-ups

- Infoblock and lighting for quideposts

- Map: paper/app?

- Final presentation and poster