



LAD 2013

Route of Experience -Tourist routes

Bicycle routes and lanes

Karppanen

Keinänen

Vuokila

Index:

Introduction	3
Why	4
Observation trip	5
Concept idea	6
Route of Experience -Tourist routes	7
Tourist routes	8
Routes and Maps	9
Guide posts	10
• sketching	11
• initial models	12
• outcome	13-15
Self Service Station	16
• sketching	17
• first version	18
• outcome	19-20
User scenario	21-22
Partners	23



Introduction

Our assignment was to develop bicycle routes and lanes, signage and route services in Helsinki and Vantaa area.

Helsinki is worth visiting outside the citycenter, so we planned bicycle routes that shows different aspects of Helsinki.

We chose tourists as our targetgroup, but the concept is suitable for all.

The goal is to make it easier to try bicycling.





Why?

-City centres have lost their value as a meeting place for people

-The city dwellers can actively participate in the city's life

-A modern city life consists of the possibilities of encounters

-Moving around other people offers positive experiences and alternative for being alone

-It is vital to boost the appreciation for cycling because only 1 in every 5 residents in Helsinki considers the city as being bike friendly





We took a bicycle trip to observe following things:



Condition of the bicycle lane

Is the route continuity?

Is there enough signs at the route?

Motor road crossings

Is the route pleasant? Is it close to the motor road?

Is the view inspiring or interesting?

Driveability: paving stones, lights, buss stops

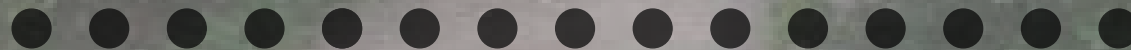

Concept Idea

Main idea in our concept is to encourage tourists to explore Helsinki wider with bicycles and use Bicycle Center services.

The Route of experience provides possibility to meet people by cycling.

We have planned routes that give different perspectives of Helsinki. Along the routes there are guideposts which helps tourists to stay on the chosen route.

Along the routes there are also Self-Service Stations. Self-service Stations includes basic tools for bicycle fixing and maintenance. There are benches in the stations where tourists can sit down, enjoy the view and have a picnic.

Information about routes and times is available in the Bicycle Center and social media. Tourists can also get the same information from hotels, hostels and Helsinki City Tourist Information.



The idea of the concept is not only to encourage foreign tourists to use the routes and the route services, but also Finnish tourists and local people in Helsinki.

Route of Experience -Tourist routes



Route of Experience -Tourist routes

We have planned different type of routes for tourists visiting in Helsinki.

Two of the routes are in use at summertime and one in wintertime.

Routes are marked with different symbols, which are used in the routemaps and in the guideposts along the route.

Marine Helsinki



Marine Helsinki route goes along sea-shore and archipelago. Landscape route views some of the beautiful nature of Helsinki.

Diverce Helsinki



Route gives cross-section of different sides of Helsinki: Urban city-view and nice landscapes at the seashore. Old town gives historical point of view to the route.

Winter Helsinki



Winter Helsinki offers extreme experiences, such as cycling on ice and snow.

Routes and maps

Marine Helsinki



Diverce Helsinki



Winter Helsinki



Cross Sections

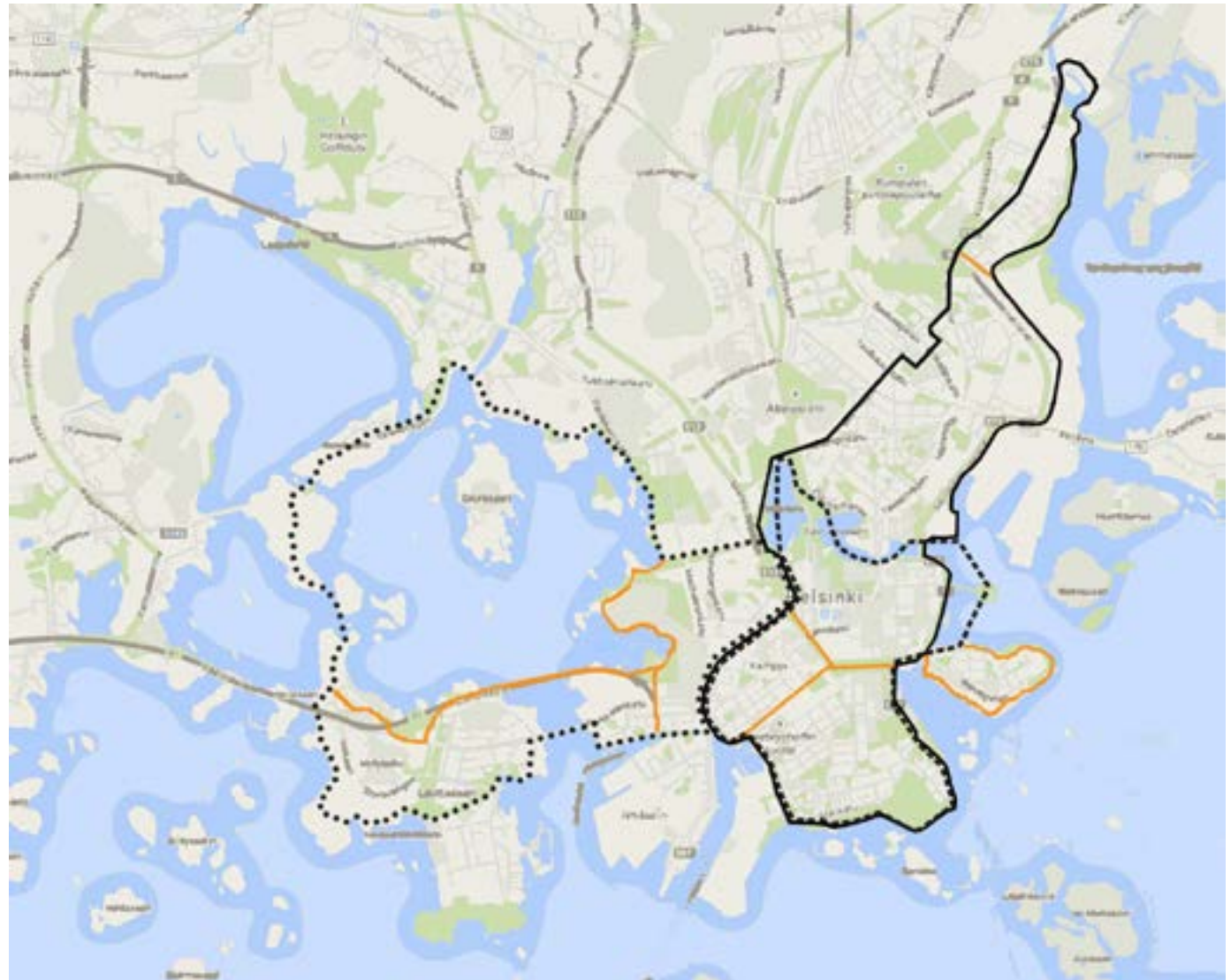

Guideposts

Sketching

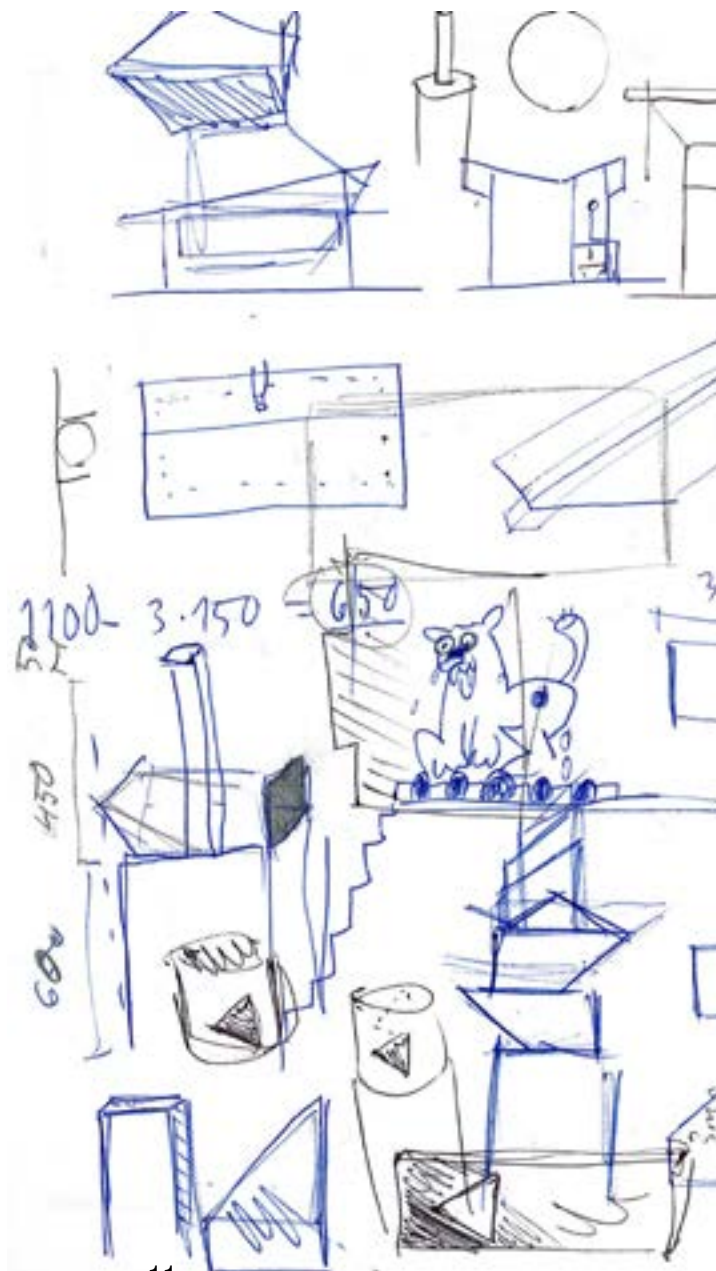
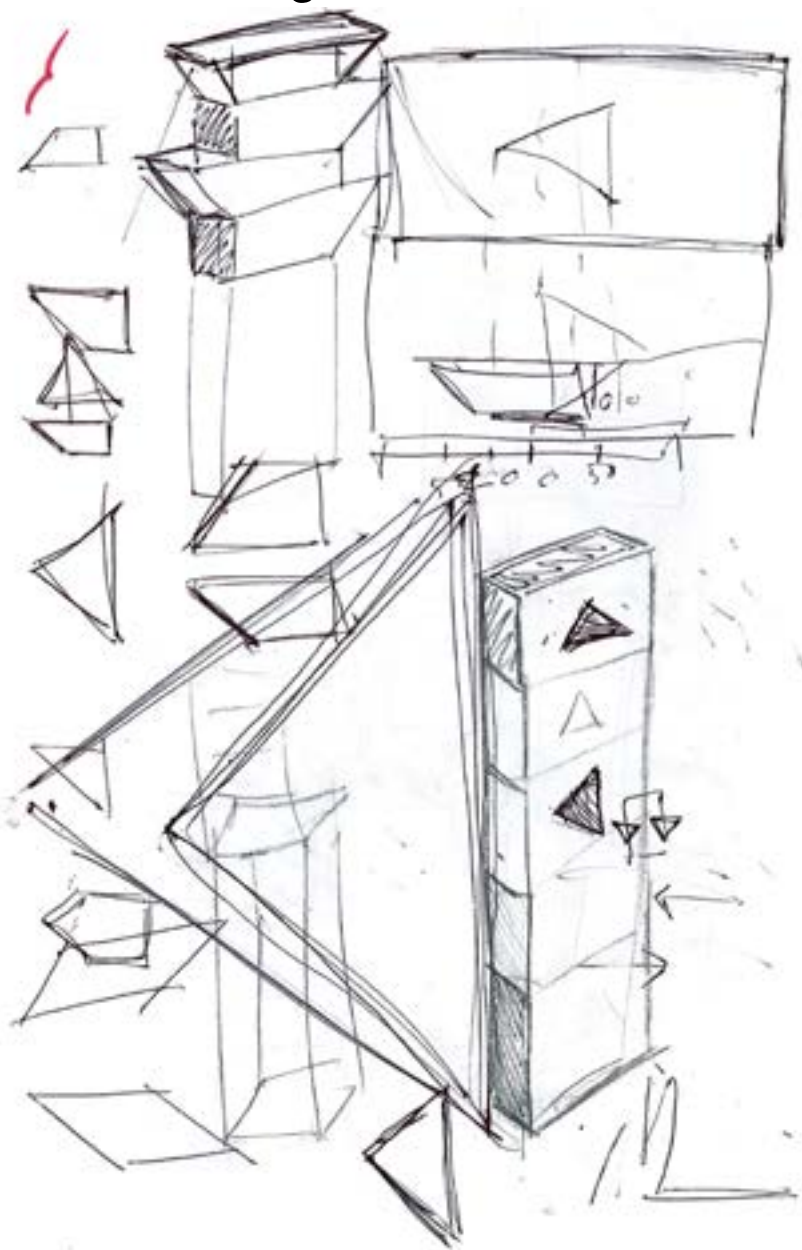

Initial models

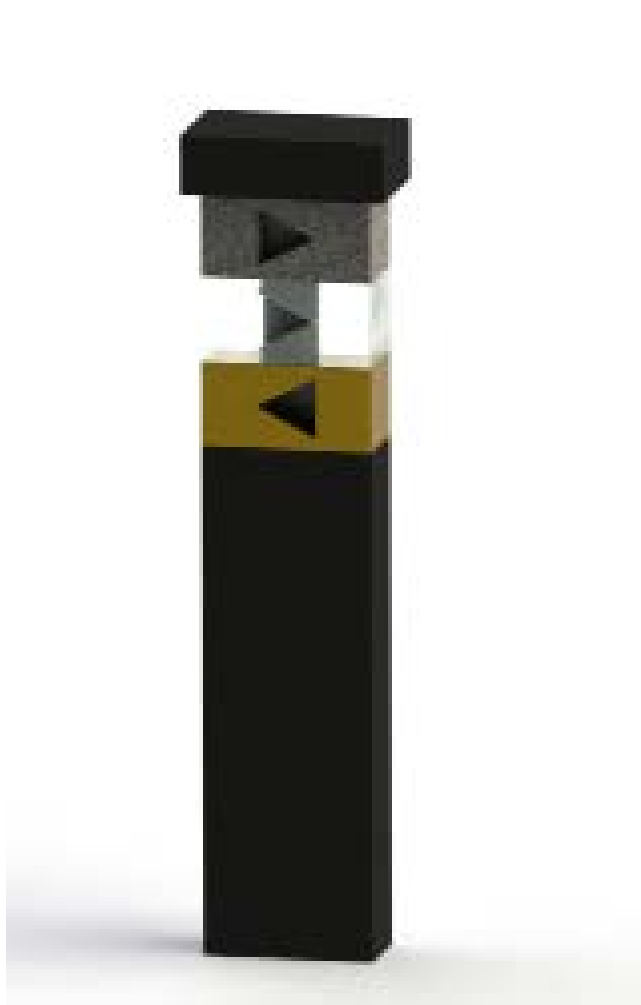
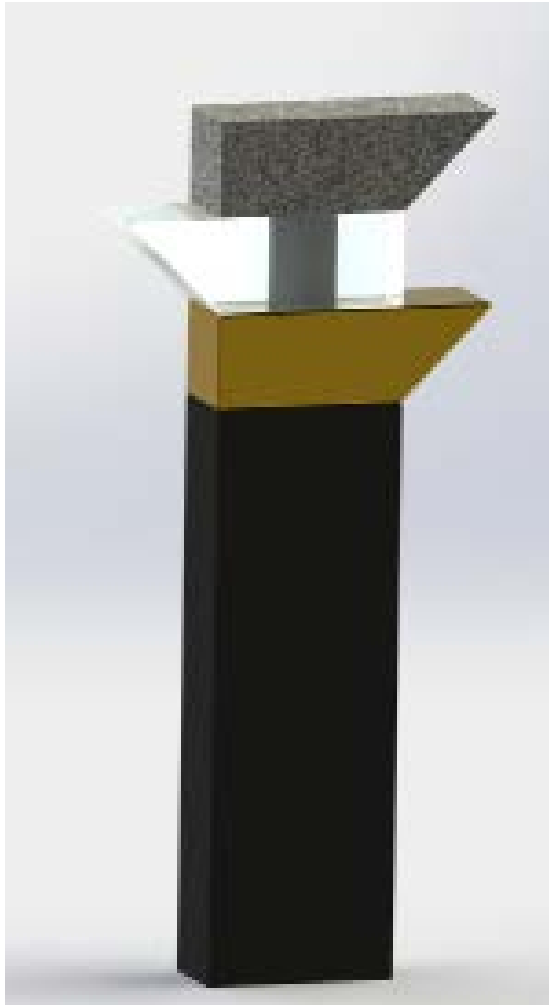

All guideposts have the same concrete base and they are designed to be modified with different materials.

Each route is marked with a different material

The blocks works also as lampposts



Guideposts

Frontside

Guideposts are made of graphic concrete and routes are marked with different symbols. Guideposts help tourists to stay in the chosen route. Guideposts have built-in led -lights so they work also as lampposts.

The guideposts are located along the route and in every crossing.

On the frontside of the guidepost is i-symbol if there is information of some nearby attraction on the guidepost ´s backside.

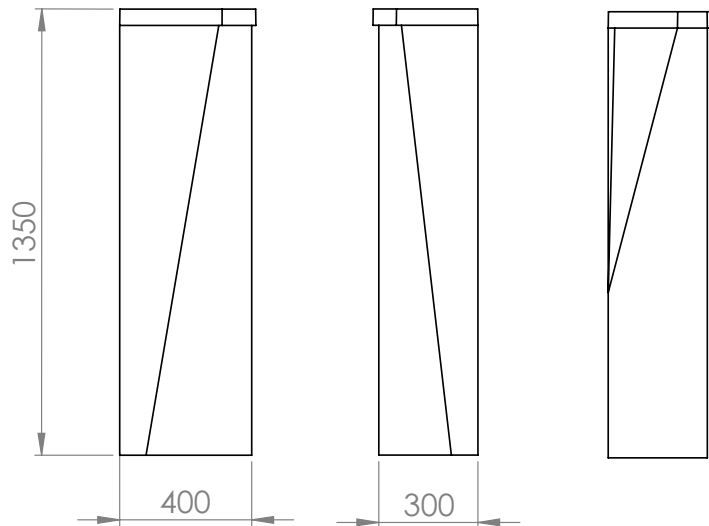

Built-in led-lights

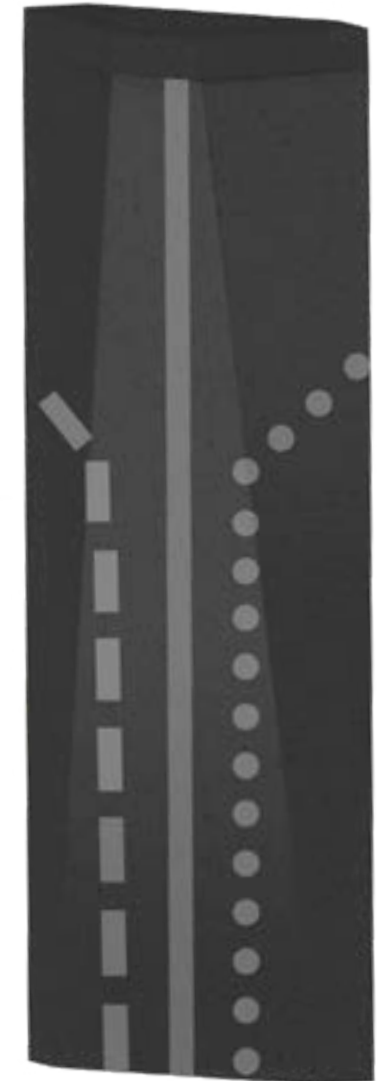

Example of a guidepost with three different routesymbols

Guideposts

Backside

On the frontside of the guidepost there is i-symbol to indicate information of some nearby attraction on the other side of the guidepost.

The information is related to culture, nature, history and beautiful landscapes.

There is also built-in led-lights on the backside of guidepost.

Area of the information is inclined, so the information is easy to read.

Built-in led -lights



Guideposts



Guidepost in use. This guidepost is from route Diverce Helsinki, from Hämeentie.



Self Service Station

Self Service Station

Process, sketching:

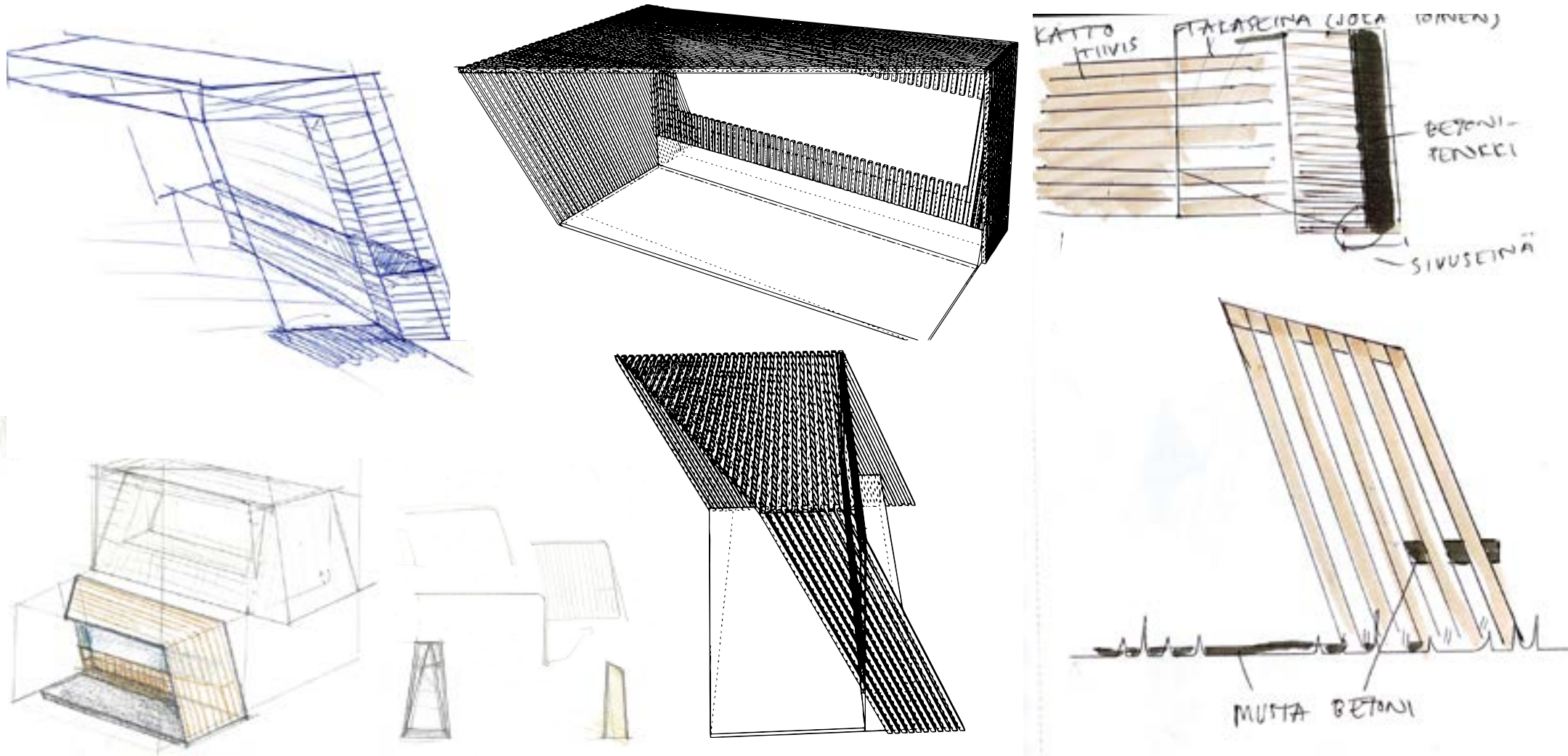



Self-Service Stations

There will be 5 self-service stations along the routes. Self-service stations are located in bicycle center, places where the routes combines and in routes zeniths.

Self-service stations includes basic tools for bicycle fixing and maintenance

Stations are sheltered and there is a bench for relaxation.

Stations can be used by tourists using the route, or local people living in the area.

Lighting is installed under the roof, between the bars.

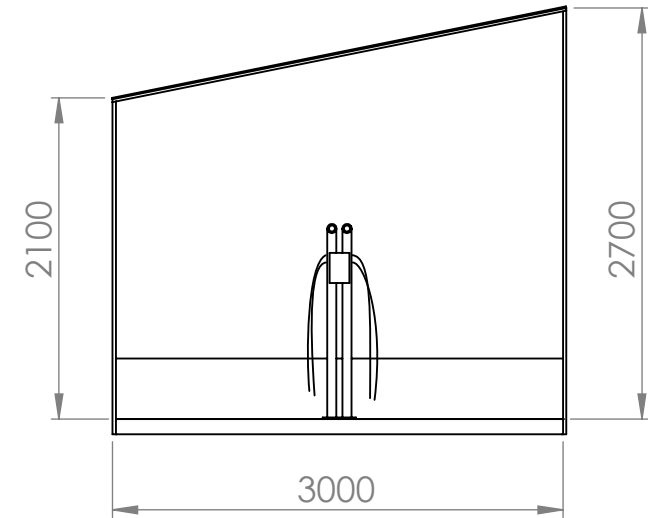

Materials:

Wood,
black concrete,
glass.

Self-Service Stations

We use Cyclehoops Public Bicycle Repair Station and Public floor pump in our Self-Service Stations

Public Bicycle Repair Stand provides a stable mount for any bike and a range of eight tools to make adjustments and repairs on the spot.

The Public Bicycle Repair Stand is designed to be bolted to a concrete surface for stability, and its reinforced construction makes it resilient to frequent public use.

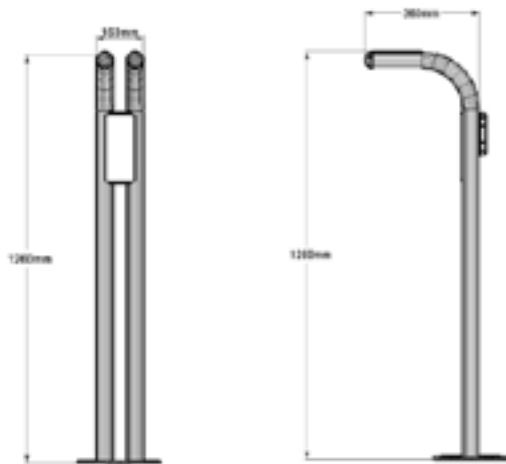

Self-service stations includes:

- Work stand
- Bike pump
- Intergrated pressure gauge
- Basic tools for bike repairing
- Simple instructions for bike fixing

Scenario

Tourist arrives to Helsinki



Tourists get the information from the hostel / hotel or Tourist Information



In the Bicycle Center tourists get the equipment and more information about the routes.



If you want to take the Marine route, follow these symbols. You can see the symbols in the guideposts so you know you're on a right track.

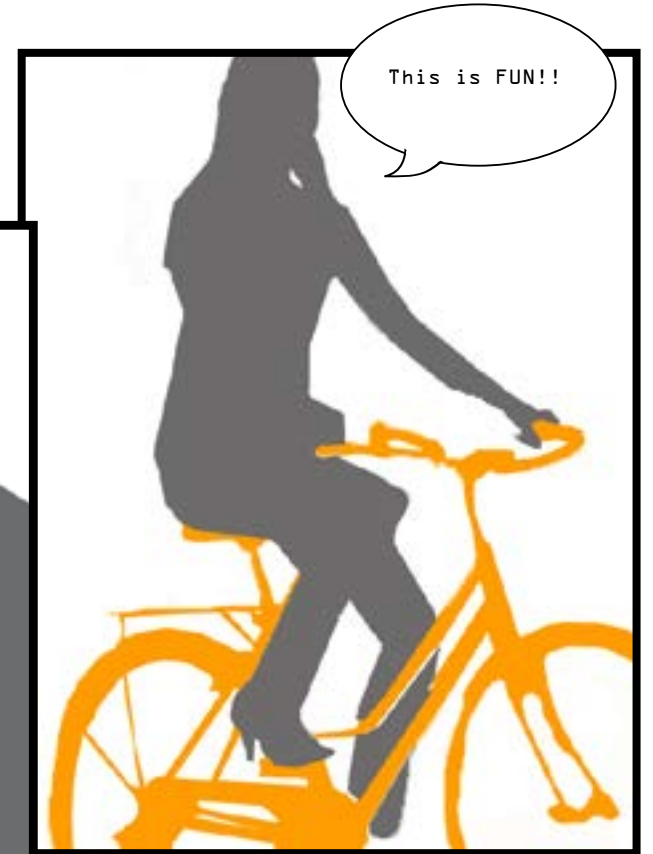

This is FUN!!

In the Bicycle Center tourists get also more information of the routes and a map.

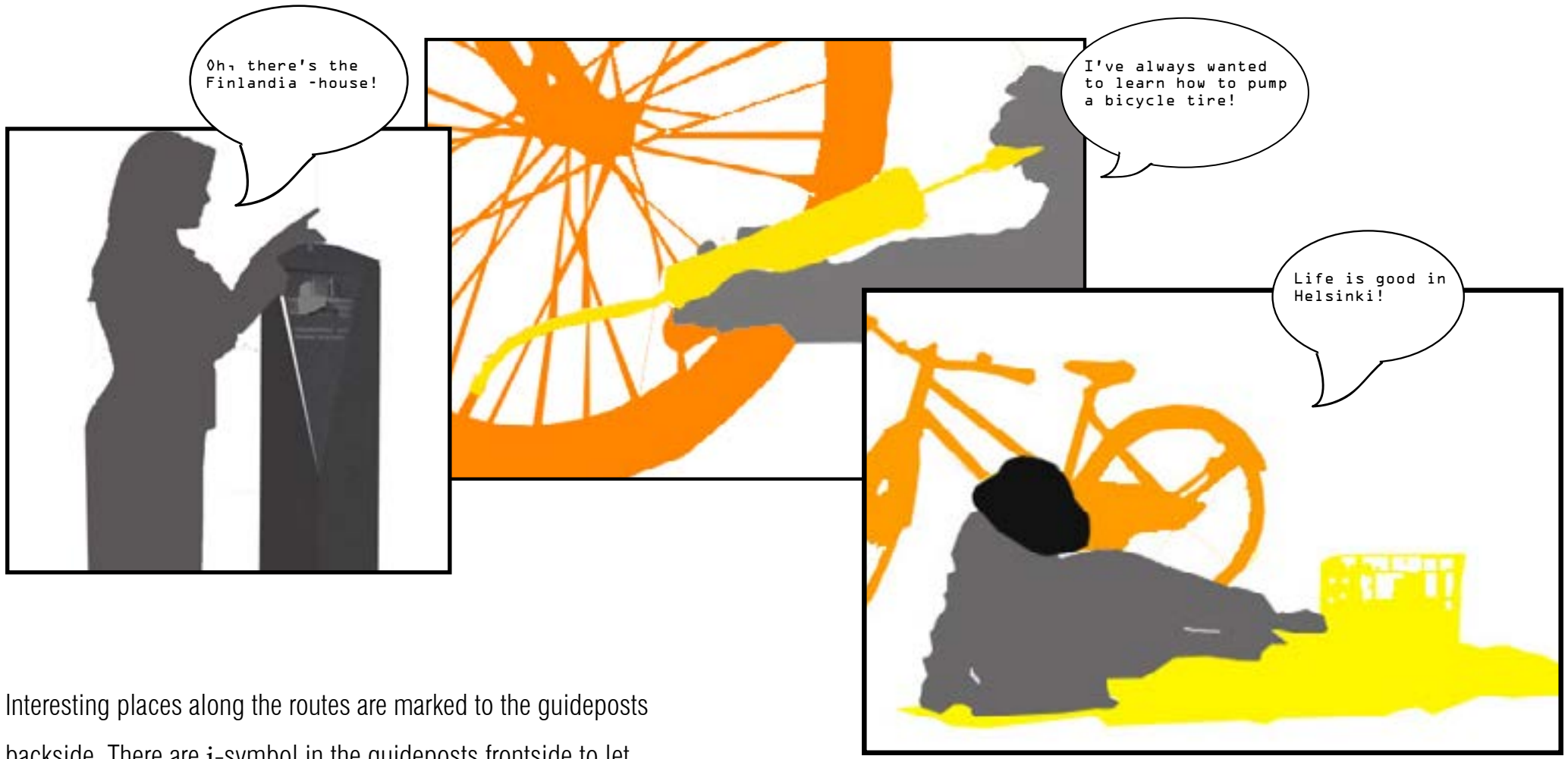

Interesting places along the routes are marked to the guideposts backside. There are i-symbol in the guideposts frontside to let tourists know there is information available on the backside.

At the Self-Service station tourist can do easy bicycle maintenance and have a picnic.

